



APPLICATION FOR AN ELECTRICITY GENERATION
LICENCE IN TERMS OF THE ELECTRICITY REGULATION
ACT, 2006 (ACT NO. 4 OF 2006).

Please return completed form to:

HOD: Electricity Licensing and Compliance
National Energy Regulator of South Africa
Kulawula House, 526 Vermeulen Street
Arcadia, 0083
Pretoria

Or:

HOD: Electricity Licensing and Compliance
National Energy Regulator of South Africa
P.O. Box 40343
Arcadia
0007

Tel (012) 401 - 4600
Fax (012) 401 - 4700

SECTION A PARTICULARS OF APPLICANT

A1 Full name of applicant (business name) and business registration number

Wilverdiend BESS (Pty) Ltd
Registration Number: 2024/126880/07

A2 Address of applicant, or in the case of a body corporate, the registered head office

Physical address

21st Floor Portside
5 Buitengracht Street
Cape Town
Western Cape
8001

Postal address

Suite 53
Private Bag X21
Howard Place
Western Cape
7450

A3 Telephone number of applicant

(+27) 21 685 3240

A4 Fax number of applicant

Not applicable

A5 Email address of applicant

wilverdiend-pmo@mulilo.com

A6 Contact person

First name **Russell**

Surname **Bedford**

Telephone No **(+27) 21 685 3240**

Mobile No **(+27) 82 558 8611**

Fax No **Not applicable**

Email address Russell@mulilo.com

A7 Legal form of applicant

SPV Company: **Wolverdiend BESS (Pty) Ltd**

Directors: **Russell John Bedford**

Registration number: **2024/126880/07**

Shareholding structure: **Please refer to the summary below**

Applicant: Company: Wolverdiend BESS (Pty) Ltd

Company registration number: 2024/126880/07

Project Shareholding: The shareholding in the Project Company will be held as follows at Financial Close:

The shareholding structure at Financial Close will be as follows:

- **51% by K2024146874 (SOUTH AFRICA) (Pty) Ltd to be named “Mulilo Wolverdiend BESS HoldCo**
- **44% by Reatile Wolverdiend BESS (RF) (Pty) Ltd (to be incorporated)**
- **5% by K2024146815 (SOUTH AFRICA) (Pty) Ltd to be named Mulilo Wolverdiend BESS Community HoldCo**

The Community Trust is in process of being incorporated and the shareholding by the Consortium is in the process of being implemented in the Project Company, as bid award by the DMRE occurred on 23 December 2024. The proposed shareholding and project structure are set out in Figure 1 and a summary of each shareholder is provided thereafter. The ring-fenced Project Company will be a special purpose vehicle (SPV) and will effectively be 100% South African-owned and 100% Black-owned.

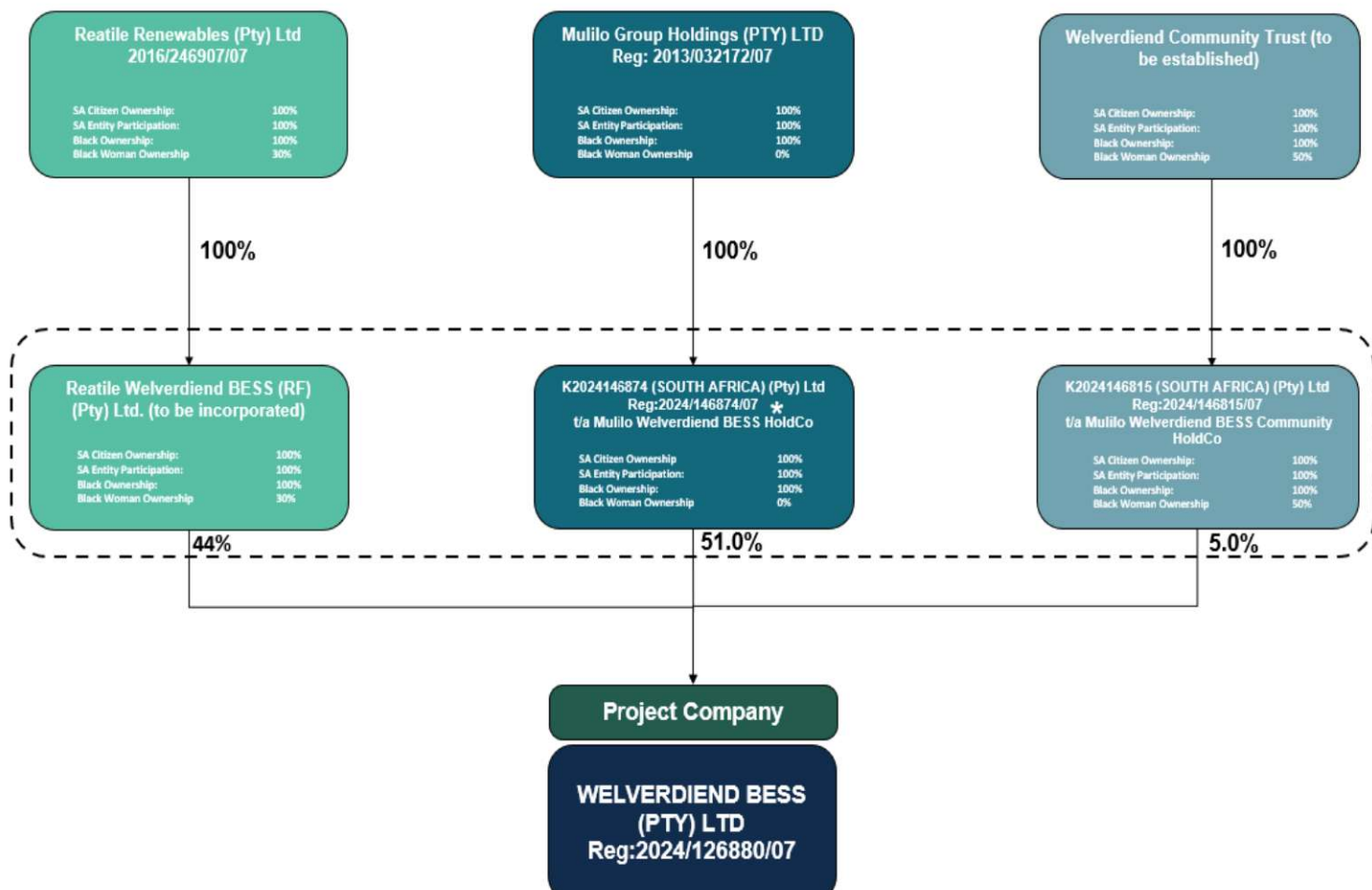

Figure 1: Project Shareholding Diagram

Mulilo Group Holdings (Pty) Ltd

- 1) Mulilo has been at the forefront of our country’s drive to deliver clean and affordable electricity since the company’s inception in 2008. Mulilo focuses on onshore wind, solar PV and battery storage technologies and develops, builds, owns and operates large scale renewable projects throughout South Africa. Mulilo has been successful in the previous BESIPPPP BW1 round, REIPPPP rounds BW1-3, 5 and 7 and in the Risk Mitigation Independent Power Producer Programme (RMIPPP) and has gained extensive knowledge and expertise in developing and financing renewable energy projects in South Africa, having been awarded 257 MW in BESIPPPP and more than 890 MW worth of projects in REIPPPP, with 420 MW currently in operation.
- 2) Mulilo has successfully raised in excess of R18 billion in debt and equity for our awarded BESIPPPP and REIPPPP projects, with their reliable performance showing the value Mulilo brings to development and operation.

Reatile Renewables (Pty) Ltd

- 1) Reatile Renewables (Pty) Ltd is a black owned investment holding company with significant stakes in many existing wind and solar projects, as well as many in the Financial Close process.

Wolverdiend Community Trust

- 1) This community trust will be formed to channel benefits emanating from the project to social responsibility programmes in the region where the project will be constructed.

Note to Section A

- 3) State whether the applicant is a local government body, a juristic person established in terms of an act of parliament, a department of state, a company or other legal body.

Juristic person (Project Special Purpose Vehicle (SPV) company)

- 4) If the applicant is a local government body, attach a copy of the proclamation establishing such body. Where the applicant is a company, the full names of the current directors and the company registration number are required.

Provided above

- 5) Also provide shareholding information of the company.

Provided above

SECTION B COMMENCEMENT DATE OF LICENCE

B1 Desired date from which the licence (if granted) is to take effect

31 August 2026 (6 months prior to planned COD)

Note to Section B

- 1) The normal processing time for a licence application is 120 days once all relevant information has been provided and there are no objections received.

Noted, the Project requests this application be expedited as far as possible to meet the stringent timelines required by the Preferred Bidder Letter of award under the private off-taker programme.

- 2) If the applicant intends operating more than one generation station under the proposed licence, please complete separate application forms for each generation station.

Not applicable, only one generation station is proposed under this license application.

SECTION C PARTICULARS OF PROPOSED GENERATION STATION

C1 Name of generation station

Welverdiend BESS

C2 Geographical location of generation station (please attach maps) and GPS coordinates (x°xx'xxx" S, y°yy'yyy" E)
 26°24'2.52"S, 27°15'9.11"E

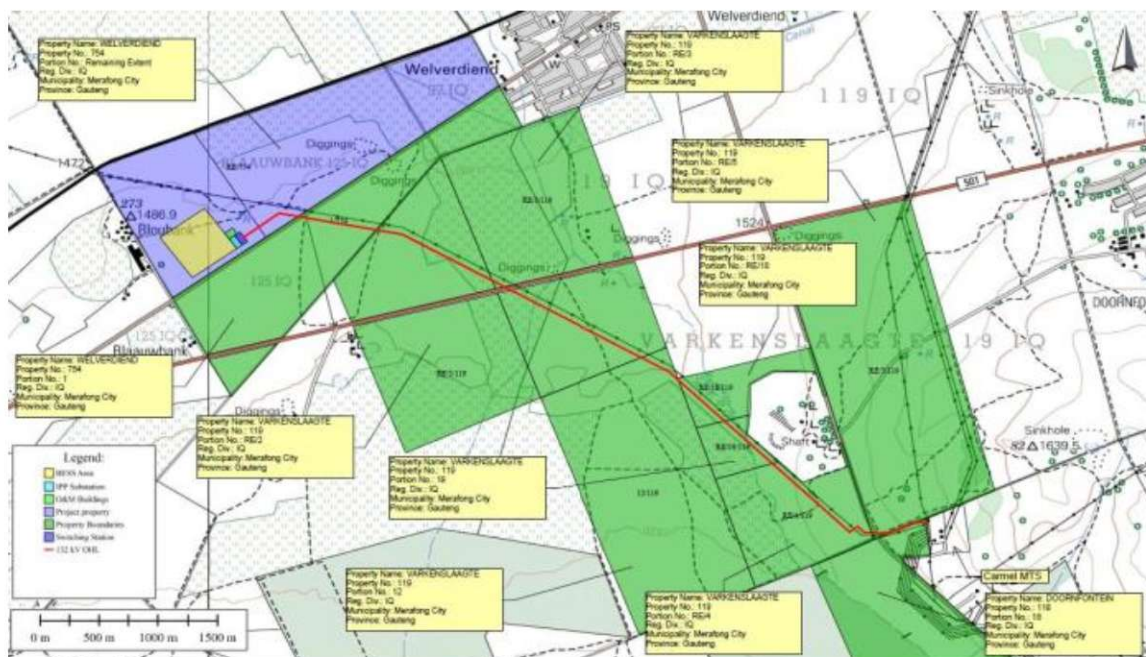

C3 Address of generation station

Remainder of the Farm Welverdiend No. 754, Registration Division IQ, North-West Province. The site falls within the Merafong City local municipality.

C4 Contact person at generation station

First name and Surname
 Telephone No
 Mobile No
 Fax No
 Email address



C5 Type of generation station (thermal, nuclear, hydro, pumped storage, gas turbine, diesel generator or other) (Please specify)

Other - Battery energy storage system – Electrochemical

The project is not a power generation facility, it is a battery energy storage system (BESS) which is charged with electrical energy from the national electrical grid, under Eskom’s instructions. As per the DMRE’s requirements, the Facility shall be allowed to draw Energy Input from the System for the purposes of storage of energy. The Facility shall be designed to ensure that the System Operator has full remote control of the Facility and sole discretion to Dispatch the charging and discharging of Energy within the Capacity of the Facility. The Facility is designed primarily for the provision of Capacity and Ancillary Services and must also be capable of operating continuously at Contracted Capacity with network frequency and voltage deviations specified in the Battery Energy Storage Facilities Code (“BESF Code”) for a minimum duration of 4 hours for each cycle.

C6 Expected commissioning date for a proposed generation station or at which the station was commissioned (if an existing station). Also state construction period required if applicable.

Milestone	Date
Financial Close	23/08/2025
Facility Construction Start Date	15/09/2025
Grid Connection Commissioning Date	08/04/2027
Commercial Operation Date	31/02/2027
Months from Financial Close to COD	18 months

C7 The installed capacity (existing and/or planned) of each unit within the generation station (MW)

Existing Capacity (Nameplate rating)

Not applicable, project is to be built, greenfield development.

Planned Capacity (nameplate rating)

**Storage Discharging Capacity/Contracted Capacity: 77 MW_{ac} / 308 MWh
Nameplate / Installed Storage Capacity: [REDACTED]**

C8 Maximum generation capacity (MW) expected to be available from the generation station and energy to be produced (MWh) over the next 5years of operation. These estimates should be based on modelling of how the power station will fit into the demand profile of its customers, taking into account the least cost energy purchase consideration and demand management options of customers.

Note that this is a grid-connected battery energy storage system, it is not a power generation facility, therefore the data reported below applies to the energy storage capacity.

Note usage in terms of charging MWh and auxiliary consumption MWh from the grid is dependent on Eskom, final designs and tendering.

Note that the values provided below show the estimated total yearly values in the indicated year. The facility has been designed to complete 730 cycles per year, as per the PPA.

YEAR	Max MW	Total MWh	Own use MWh	Export (Sales) MWh
1	77			
2	77			
3	77			
4	77			
5	77			

C9 Estimate of the energy conversion efficiency of the generation station/ Capacity factor where applicable.

For Battery Energy Storage Systems, Round Trip Efficiency (RTE) is the metric used to discuss system efficiency. It is calculated as a ratio of the energy input and energy output. Additionally, the availability factor is used to indicate how often the stored energy is available for dispatch. This factor takes into account maintenance periods, augmentation periods, and any other periods where the battery may not be available.

The availability factor is greater than [REDACTED] when considering all planned outages.

The table below details the yearly RTE values. These values are estimates and are dependent on the completion of final design and tendering with suppliers

Year	Round Trip Efficiency (%)
1	[REDACTED]
2	[REDACTED]
3	[REDACTED]
4	[REDACTED]
5	[REDACTED]
6	[REDACTED]
7	[REDACTED]
8	[REDACTED]
9	[REDACTED]
10	[REDACTED]
11	[REDACTED]
12	[REDACTED]
13	[REDACTED]
14	[REDACTED]
15	[REDACTED]

C10 Expected future life of the generation station.

The battery will be operational for 15 years. Additional containers will be added to the initial installation (Augmentation) to maintain the contracted capacity. The optimal augmentation occurs as shown in the table below.

Project Year	Y0	Y1	Y2	Y3	Y4	Y5	Y6	Y7	Y8	Y9	Y10	Y11	Y12	Y13	Y14	Y15
Total MWh	[REDACTED]															

Please see Annexure “C” containing the feasibility study for this project as well as a single line diagram detailing network connection.

Note to Section C

Also provide additional technical information of the project as separate attachments. This should give the technology used, technical feasibility studies e.g. radiation studies for Solar projects or wind studies for Wind projects, connection to the grid arrangements, single line diagrams of the network connection as well as single line diagrams of the generation station, etc. Also attach fuel supply/ wheeling/ connection consents/ agreements where applicable (if you are going to use someone else’s network).

This information is also used as technical inputs to the financial model of the project, e.g. solar radiation studies will determine the amount of power that can be generated.

**SECTION D PARTICULARS OF LONG TERM ARRANGEMENTS WITH
PRIMARY ENERGY SUPPLIERS**

D1 Name of primary energy supplier/s (mining house, colliery or other fuel supplier)
if applicable

According to the Power Purchase Agreement (PPA) to be executed between the Project and the DMRE, the Facility is authorized to obtain energy from the Eskom's Bighorn substation through the transmission system for energy storage. The facility will be linked to the transmission system in accordance with the Connection Agreement to be executed. Eskom is the System Operator. The battery storage facility will have the right to and capability to utilize energy from the transmission system, including energy input and for auxiliary consumption as directed by Eskom through dispatch instructions. The BESS will store energy from the transmission system and discharge it back into the transmission system.

**Net Dependable Capacity (NDC): 77 MW
Capital Cost Recovery Charge rate (CCR): ████████ R/MW/h in the first year, subject to CPI thereafter
Charging of energy from the grid will be supplied by Eskom at a rate as per the RFP base tariff for energy was stated to be 518.89/MWh.**

D2 Particulars of the contractual arrangements with primary energy supplier if applicable

The PPA will be for a duration of 15 years between the Project and Eskom. An implementation Agreement, Direct Agreement and Use of System will also be signed. The energy supply price/ Capital Cost Recovery Charge rate (CCR) is fixed in the PPA, the Tariff for the Energy Input and Auxiliary Consumption delivered at Delivery Point, is charged as a fixed rate per MW/h, subject to CPI.

Remuneration: Capacity payment (to be quoted) = R/MW/Month

Notes to Section D

- 1) Please provide brief particulars of any long term agreements entered into with fuel suppliers and copies of such contracts (Signed Fuel Supply Agreements).

A copy of the PPA and Use of System Agreement, as provided by the DMRE is contained in Appendix B.

SECTION E MAINTENANCE PROGRAMMES AND DECOMMISSIONING COSTS

E1 Details of any proposed operation and maintenance programmes, including the expected cost and duration thereof, covering the lifespan of the project. Project proposals to state the expected availability, planned outage rate and forced outage rate of the plant over the life span of the project. Additional information may be provided as an attachment.

Typical BESS maintenance includes scheduled, unscheduled and preventive maintenance. These are not major maintenance programmes and will therefore not affect the contracted storage capacity of the facility. The availability factor is greater than [REDACTED] taking into account all planned outage rates and forced outage rates.

E2 Details of any major decommissioning costs expected during the life span of the power station and provided for in the project feasibility study.



E3 Details of major generation station expansion and modifications planned for in the feasibility study (Dates, Costs in Rands (state year) and description)



SECTION F CUSTOMER PROFILE

F1 Particulars of the person or persons to whom the applicant is providing or intends to provide electricity from the generation station. Explain relationship between buyer and seller if any.

Eskom Holdings Limited (Registration Number: 2002/01527/30), or any company succeeding it as determined by law. The applicant was awarded Preferred Bidder status under the BESIPP Procurement Programme (Tender No.:DMRE/016/2023/24). Under the

Programme, Eskom is the designated Buyer. As such, the applicant will enter into a 15-year Power Purchase Agreement (“PPA”) with Eskom for the sale and purchase of battery energy storage capacity.

F2 Network connection details (connection points, voltages, wheeling arrangement, single line diagram). Please attach connection cost estimate letters and / connection consents if not owner of the network.

The Project Company has applied for grid connection under the Eskom self-build Programme, as such the Project Company will construct the grid connection works and transfer the assets over to Eskom at COD.

In addition, a Cost Estimate Letter (CEL) has been issued by Eskom confirming that the Project can be connected to the grid at the Carmel substation. The BESS will be connected to the Eskom grid by constructing an onsite 132/33 kV substation, a 132 kV switching station, and a ±6.7 km power line that connects to Eskom’s Carmel MTS. Metering will be done at Welverdiend SWS, switching station.

A Cost Estimate Letter (CEL) has been issued by Eskom confirming a full self-build scope, refer to Appendix C. A Budget Quoted Request has also been lodged and is in process with Eskom.

Planned voltage connection level: 132 kV

Planned connection point: Onsite 132/33 kV substation

The Single Line Diagram is shown in the Figure below:

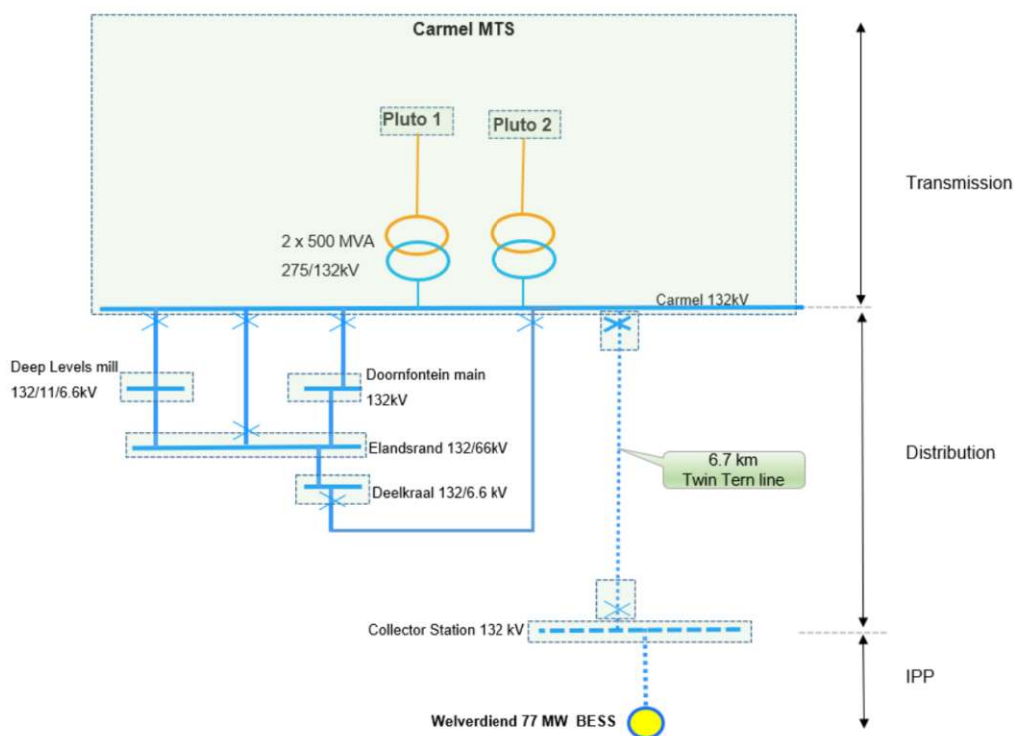

F3 Provide summary details of Power Purchase Agreements with customer including purchasing price etc. (Please attach Power Purchase Agreements).

The PPA will be for a duration of 15 years between the Project Company and Eskom. The draft PPA was issued as part of the RFP (Tender No.: Tender No.: DMRE/016/2023/24). The PPA is contained in Appendix B.

The energy supply price is fixed in the PPA, the Tariff for the Energy Input and Auxiliary Consumption delivered at Delivery Point, is charged as a fixed rate per MW/h, subject to annual escalation by CPI.

The purchase price (tariff) or Capital Cost Recovery Charge Rate (CCR) in Rand per MW per hour for Contract Year n-1 approved as part of the bid award is [REDACTED] Rand/MWh at the date of the bid submission (29 August 2024).

Dispatching assumption: Battery Storage Capacity for 4 hours and 730 equivalent number of cycles per annum

Notes to Section F

- 1) For example, supply to ESKOM or supply to local government distribution system. Please include the details of power purchase agreements entered into and the price structure of the contract.

SECTION G FINANCIAL INFORMATION

- G1 Submit projections of and current statements of the accounts in respect of the undertaking carried on by the applicant, showing the financial state of affairs of the most recent period, together with copies of the latest audited annual accounts where such have been prepared.

The Project is held through the Project Company which is a special purpose vehicle (“SPV”), established for the sole purpose of developing, financing, building, owning and operating the Project. There are no audited annual accounts at this stage and the SPV is a dormant shelf company which will be activated prior to financial close of the Project.

- G2 Submit the financial model in excel format of the proposed generation facility for the lifespan of the project, showing the funding (Equity/ Debt ratios) and their cost, cost of the project, sales and revenues generated by the project, stating the assumptions underlying the figures. A separate write up must be provided to explain the financial information on the model.

The Financial Model (FM) and the FM User Guide are contained in Appendix D. Please refer to G3 below for detailed project cash flow projections.

- G3 Estimates of net annual cash flows for the lifespan of the project sufficient to demonstrate the financial security and feasibility of operating the generation station.

The estimated annual cash flows for the lifespan of the Project are detailed in the Financial Model in Appendix D. A cash flow statement is included and detailed per 1 year period.

The project cash flows demonstrate the financial feasibility of the Project. The Project must meet key liquidity, profitability and solvency ratios requested by its Lenders.

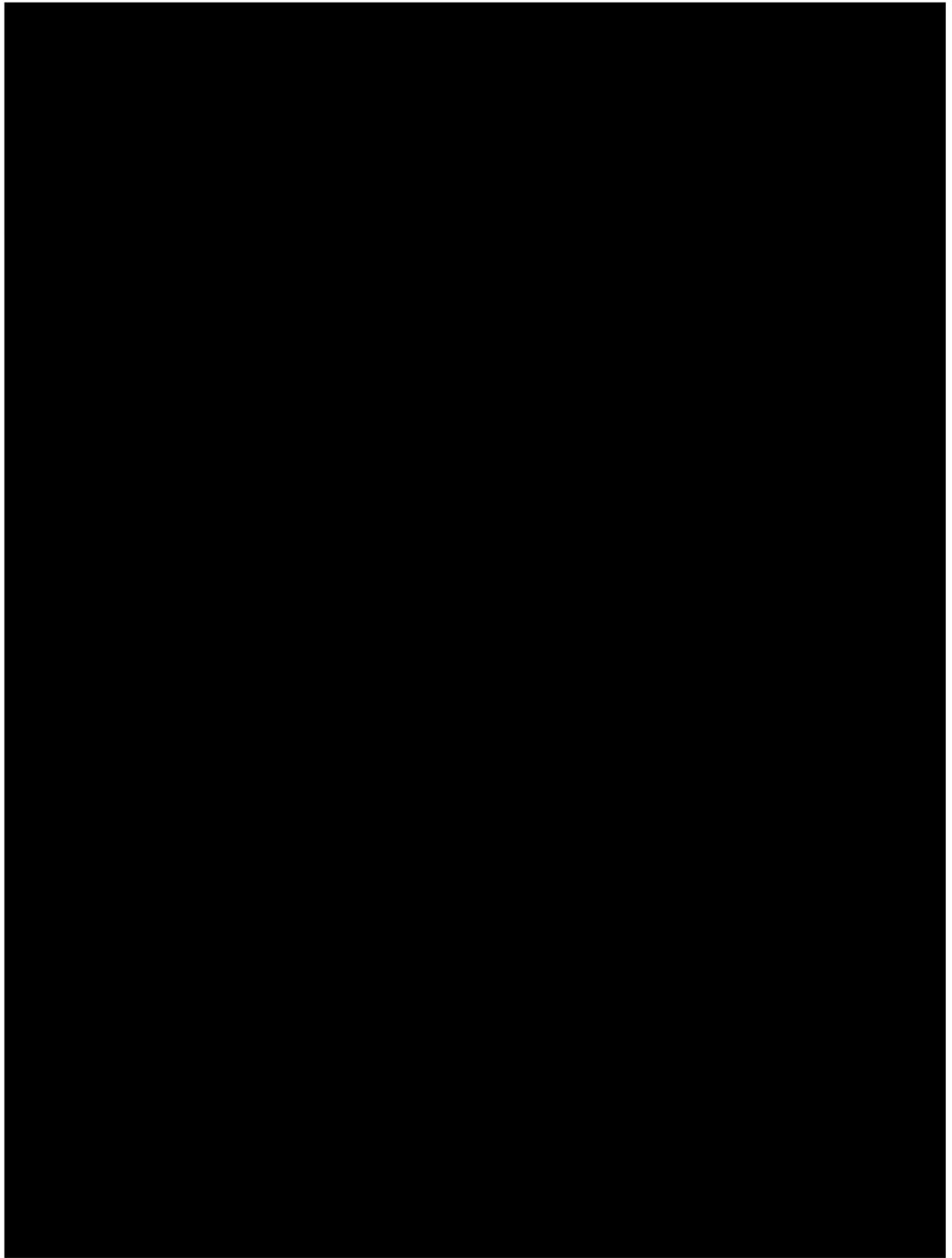

G4 Project financing: Who will finance the project, how is funding split between debt and equity, and what is the terms and conditions of the funding agreements. In addition, also fill in table below:

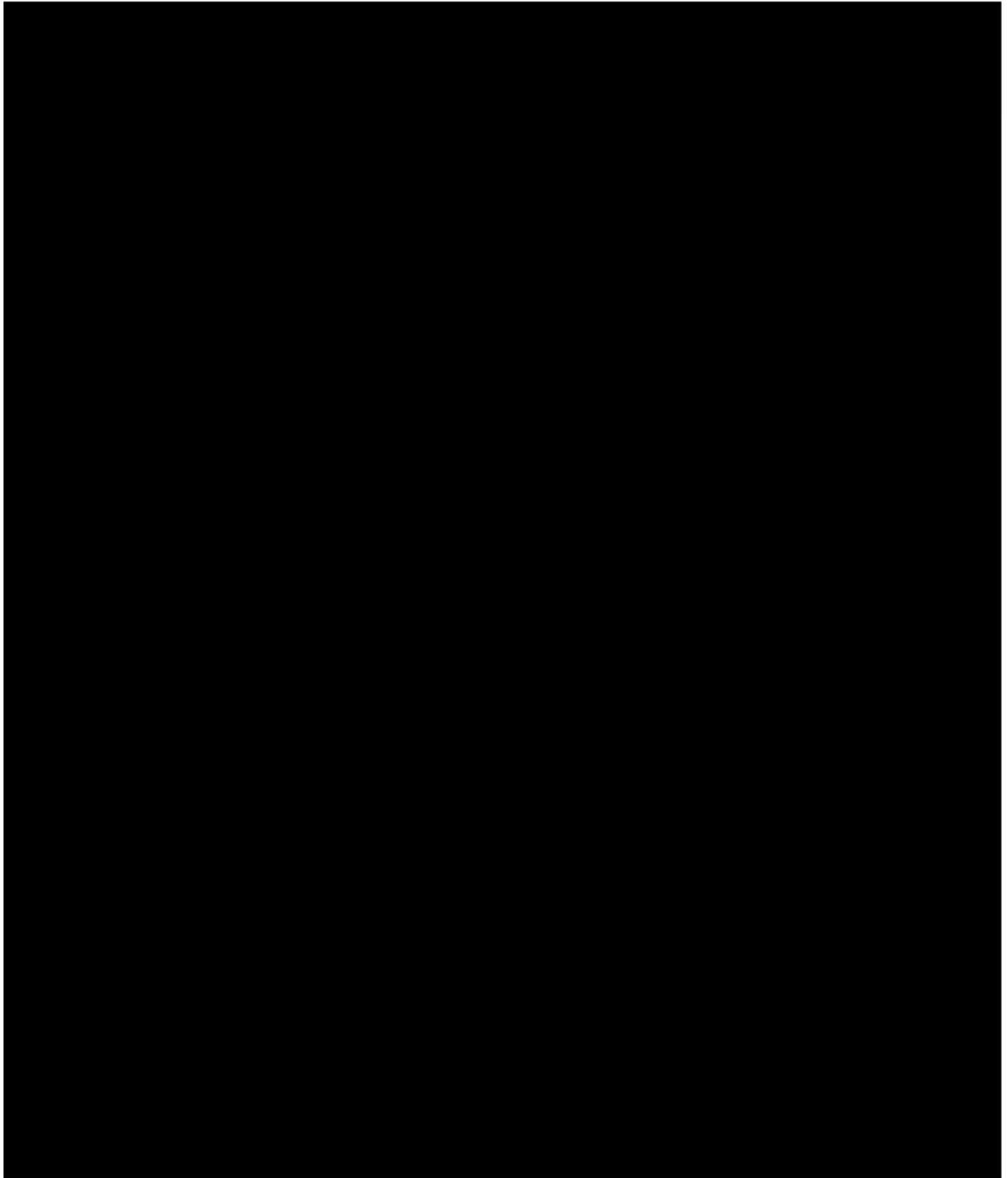

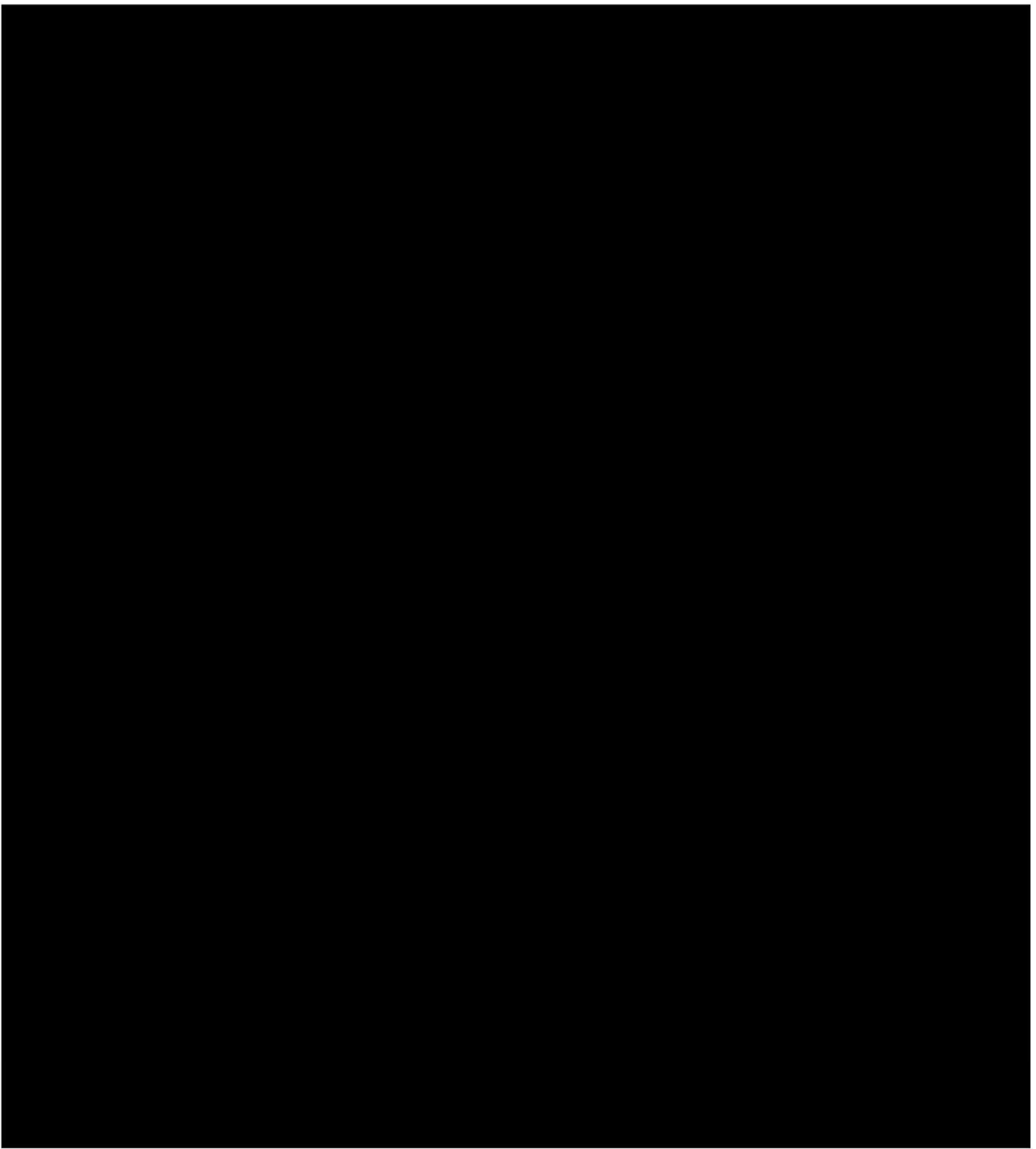

Notes to Section G

- 1) The financial projections should be based on a production plan for the generation station and the revenue generated by participating in the electricity market and by bilateral contracts (Power Purchase Agreements) with customers. Reference to the latest version of National Integrated Resource Plan (IRP) is required to demonstrate

that the proposed power purchase agreement is the least cost solution available to the electricity purchaser.

- 2) Evidence of compliance with the Integrated Resource Plan (IRP). If the proposed plant is not in the IRP, the applicant must obtain Ministerial approval for deviation from the IRP in accordance with Section 10(2)g of the Electricity Regulation Act, 2006 (Act No. 4 of 2006). This approval is granted by the Minister of Energy so applicant must contact the Department of Energy for this approval. The DDG: Policy would be the contact person at DoE. Sometimes the Minister gives a blanket approval, and applicants are encouraged to contact NERSA for the latest update on what is exempted.

SECTION H HUMAN RESOURCES INFORMATION

H1 Submit details of the number of staff and employees and their designation (not names, e.g. three professional engineers registered with ECSA, two clerks etc) in the service of the applicant at the generation station and in any support services separate from the generation station. Also provide information regarding relevant qualifications and experience in critical areas e.g. Professional registration (Engineering Council of South Africa – ECSA), Government Certificate of Competency.

Human Resources should comply with BBEEE policy or the requirements of the Request for Proposal (RfP) documents if the project is as a result of a tendering procurement process, e.g. the DMRE Renewable Energy Independent Power Producer Procurement (REIPPP) process. The applicant should give the number of employees that will be employed during project construction, operation and maintenance.

All this information should be submitted as an attachment.

Table of staff, their designations is attached as Appendix F

**SECTION I PERMISSION FROM OTHER GOVERNMENT
DEPARTMENTS OR REGULATORY AUTHORITIES**

- I.** What progress has been made to obtain the required permits and approvals for the generation project? Please provide copies of permits issued in respect of the operation of the generation station such as Environmental Authorisations, Water Use Licence, Civil Aviation Authority Approval, etc. (this is depended on technology used).

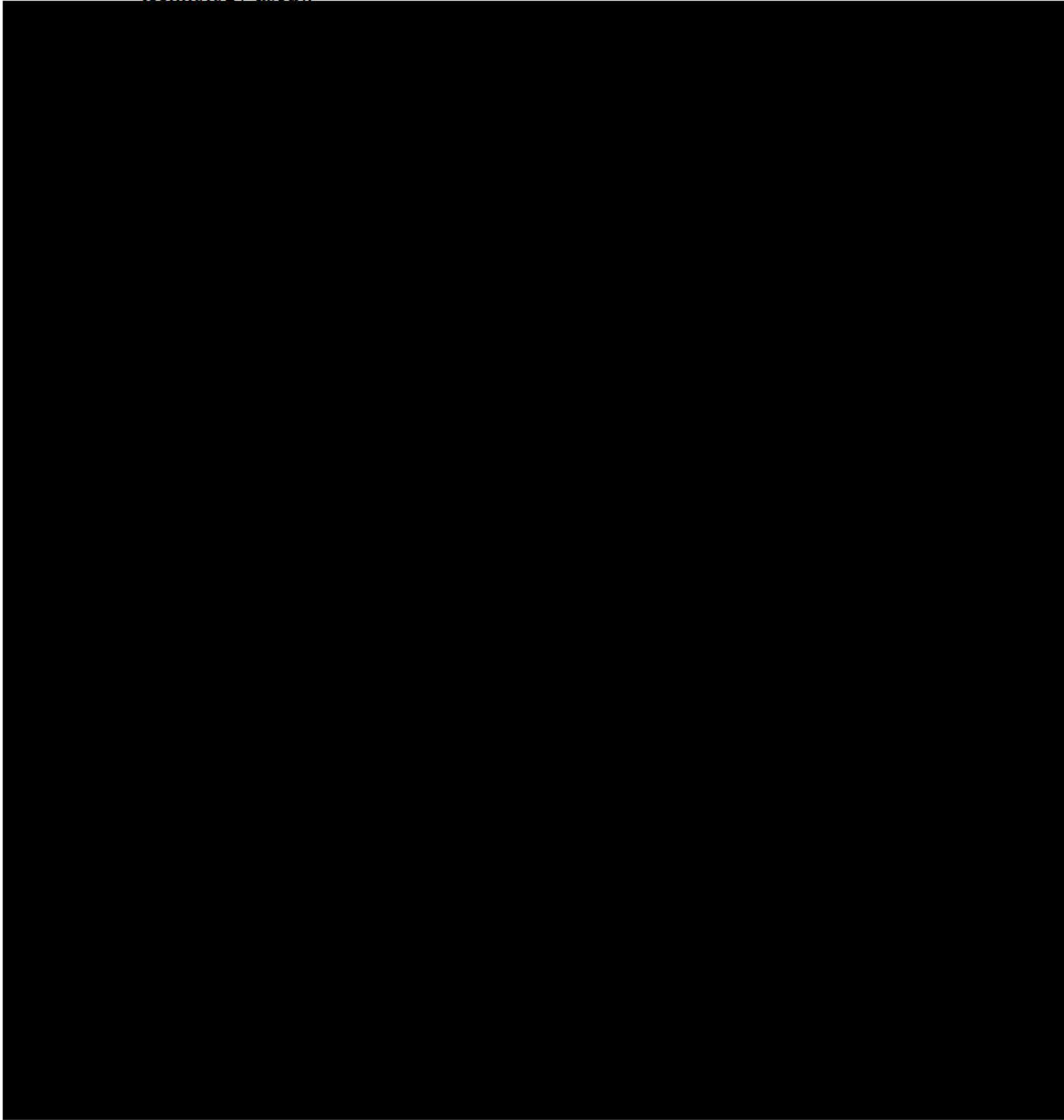

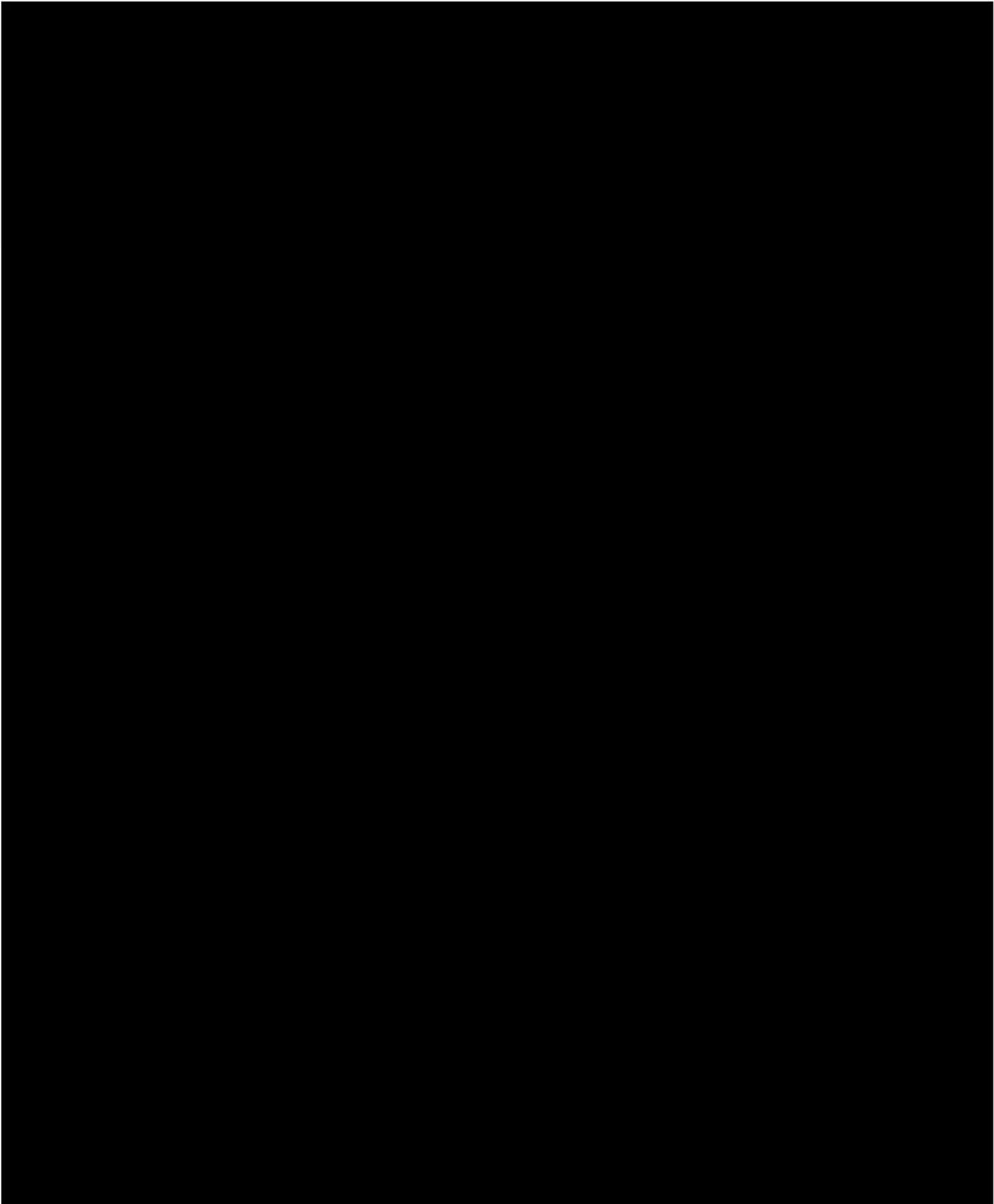

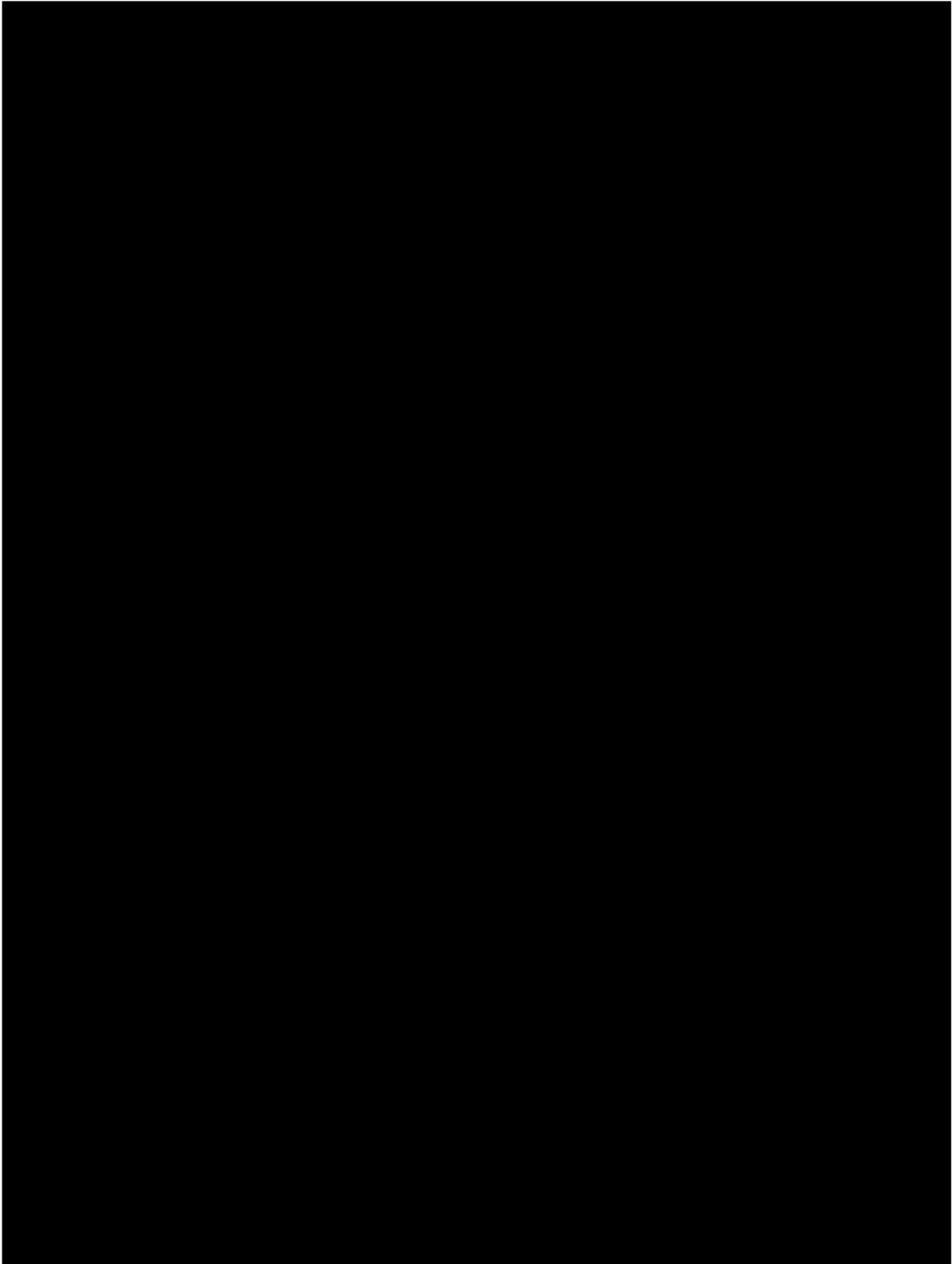

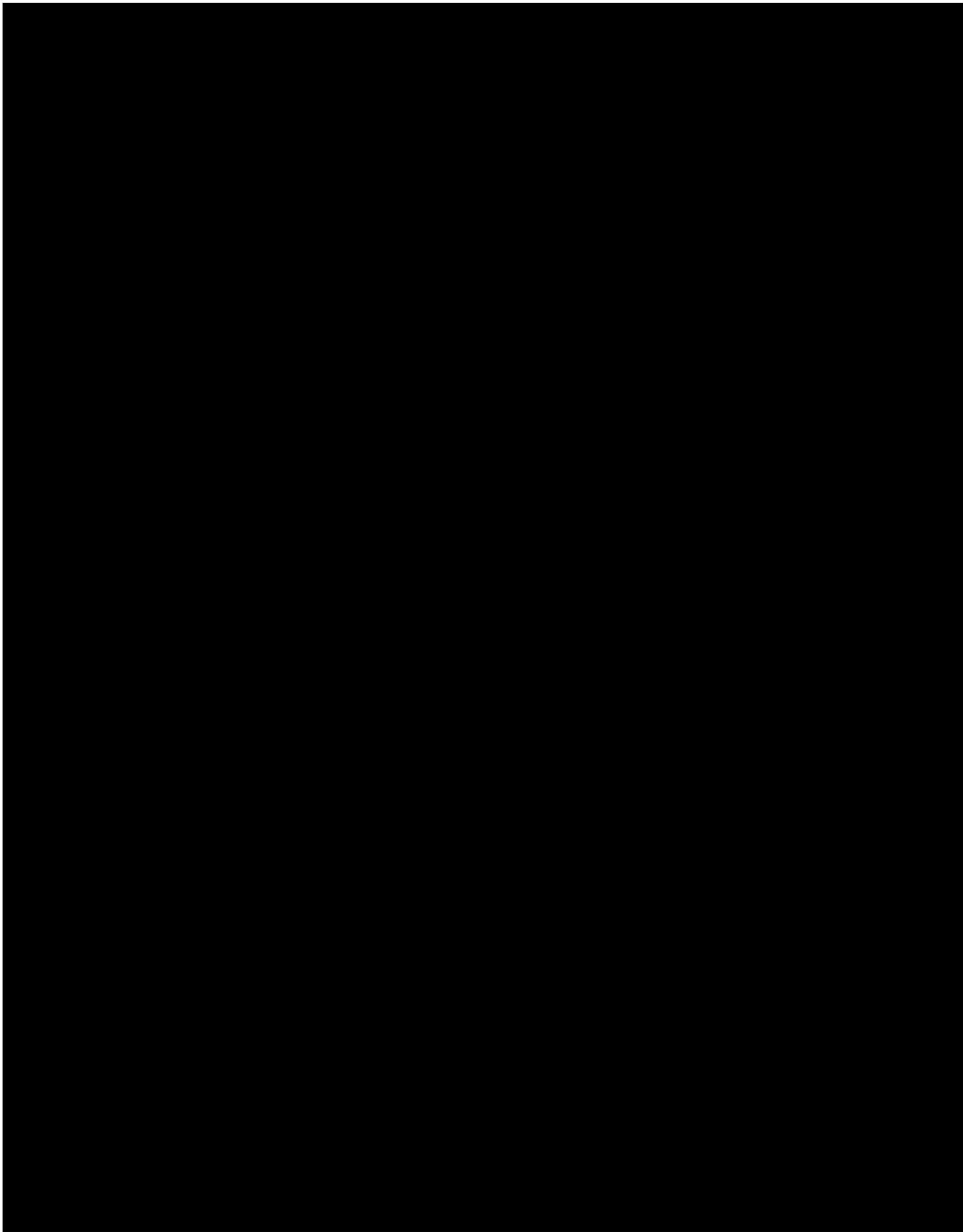

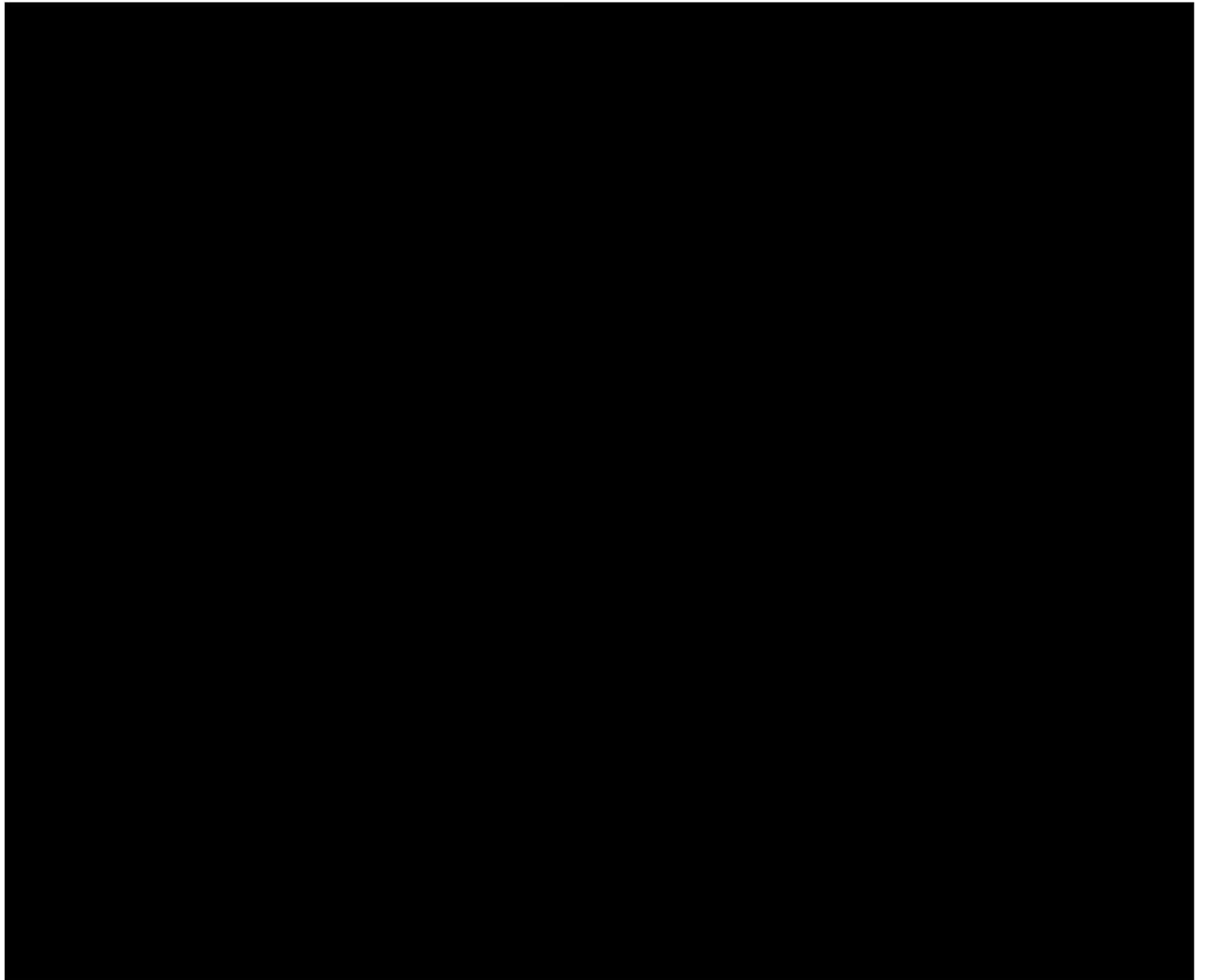

SECTION J BROAD-BASED BLACK ECONOMIC EMPOWERMENT

J1 Please provide information in terms of the following categories:

COMPONENTS	POINTS	0.5	0.75	1
Direct Empowerment	Black Ownership			
	Black Management			
	Black Female Management			
Human Resource Development	Black Skilled Personnel as % of payroll			
	Skills Development Programs as % of payroll			
	Employment Equity i.e. Women Representation			
Indirect Empowerment	Procurement from Black/BEE Suppliers			
	Enterprise Development i.e. Monetary Investment or quantifiable non-monetary support in SMME with BEE contributions as % of Net Asset Value/ EBITDA/Total Procurement			
	Industry specific initiatives to facilitate the inclusion of black people in the sector as % of net profit			
NERSA's Discretionary Points	Based on skills transfer and fulfilment or acceleration of other national objectives e.g. employment of disabled personnel robust implementation of mechanisms to verify the BEE status of suppliers reported under preferential procurement and utilization of DTI approved accreditation agencies and so on.			

SECTION K ECONOMIC INFORMATION

Please state the economic benefits of the project to the local community and to South Africa as a whole. If there are Economic Development Commitments made, they must be stated here or be provided as attachments if the files are big, but in such cases, there should be a brief summary.

The project directly addresses the grid constraints and the economic impact of the power shortages in the country. Notwithstanding the technology and purpose of the project, the Project Company has undertaken specific commitments in respect of “Economic Development” (ED) as prescribed in the Bid RFP and legally binding in the Implementation Agreement.

The Project Company has maintained an approach that is inclusionary towards local communities across the project value chain. At the project company level, this includes shareholding of 41% Black, 12% Black Women and 5% towards Local Communities. Across the remainder of the value chain the following commitments are undertaken with a view to prioritise expansion to local communities.

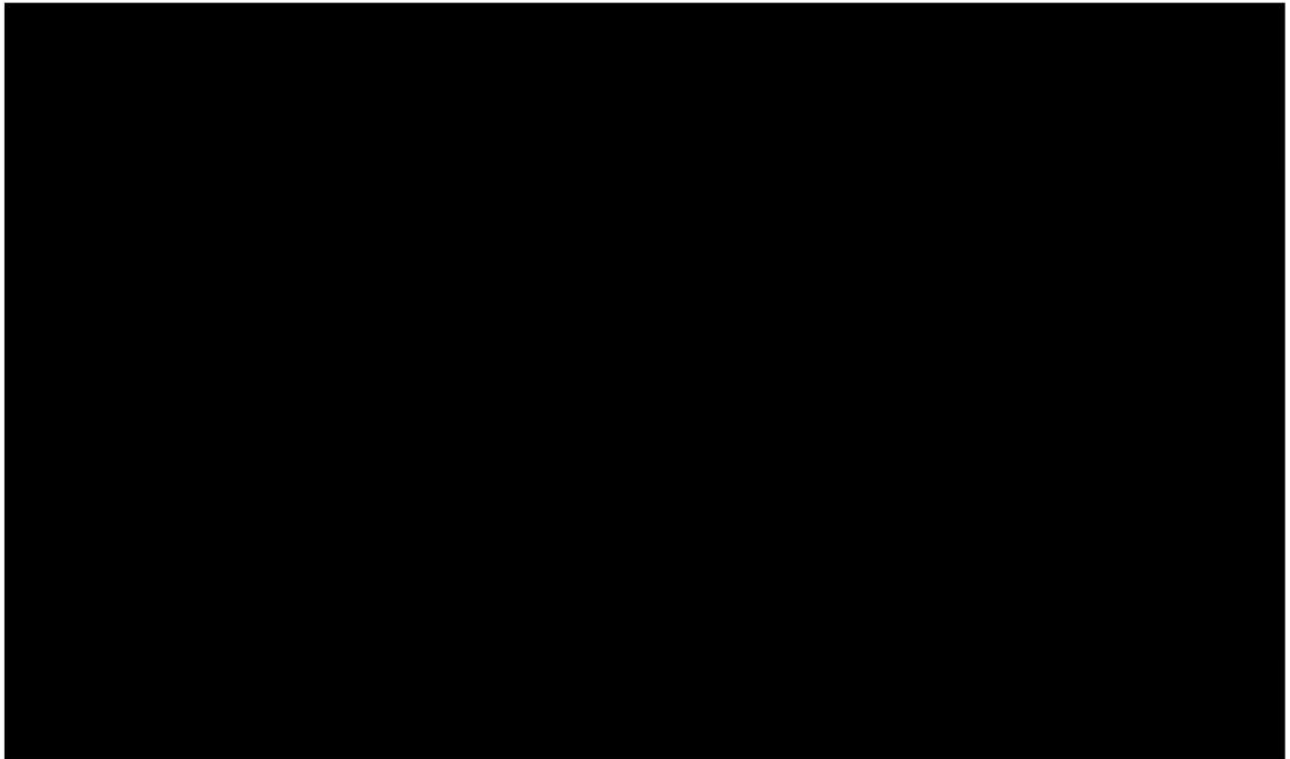

SECTION L ADDITIONAL INFORMATION

Provide any other relevant information related to this application

SECTION L DECLARATION

On behalf of the applicant, I hereby declare that:

- (a) the applicant shall at all times comply in every respect with the conditions attached to any licence that may be granted to the applicant;
- (b) the applicant shall at all times comply with lawful directions of the National Energy Regulator of South Africa;
- (c) the information provided by me on behalf of the applicant is accurate and complete in all respects; and
- (d) I am authorised to make this declaration on behalf of the applicant.

Signed:

 <p>Signed by: 8B385ECD48CF480...</p>
--

Full name(s) of Signator(y/ies):

Russell Bedford	
-----------------	--

Position held (if the applicant is a company, co-operative, partnership, unincorporated association or any other body corporate):

Chief Financial Officer	
-------------------------	--

Date:

05-Mar-25 12:58 SAST

- **Appendix A: Shareholding Structure**
- **Appendix B: PPA and System Use Agreement**
- **Appendix C: CEL and Feasibility Study**
- **Appendix D: FM and User Guide**
- **Appendix E: Lender Information**
- **Appendix F: Human Resources**
- **Appendix G: Permitting**
 - **Appendix G1: Option Agreement**
 - **Appendix G2: Land Claims**
 - **Appendix G3: Rezoning**
 - **Appendix G4: Section 53**
 - **Appendix G5: EA**
 - **Appendix G6: Water Confirmation**
 - **Appendix G7: Waste Confirmation**
 - **Appendix G8: SAHRA**
 - **Appendix G0: SARAO**
 - **Appendix G10: SAWS**
 - **Appendix G11: Cell C**
 - **Appendix G12: MTN**
 - **Appendix G13: LIT**
 - **Appendix G14: Sentech**
 - **Appendix G15: Telkom**
 - **Appendix G16: Vodacom**
 - **Appendix G17: CAA**
 - **Appendix G18: SANDF**
- **Appendix H: Project Info**
- **WULA**